

DRAINAGE AND EROSION CONTROL

J. David Rogers, Ph.D., P.E., P.G.
Karl F. Hasselmann Chair in Geological Engineering
Missouri University of Science & Technology
for the course

GE 441 Geotechnical Construction Practice

Part 1

PHYSICAL FACTORS CONTROLLING EROSION

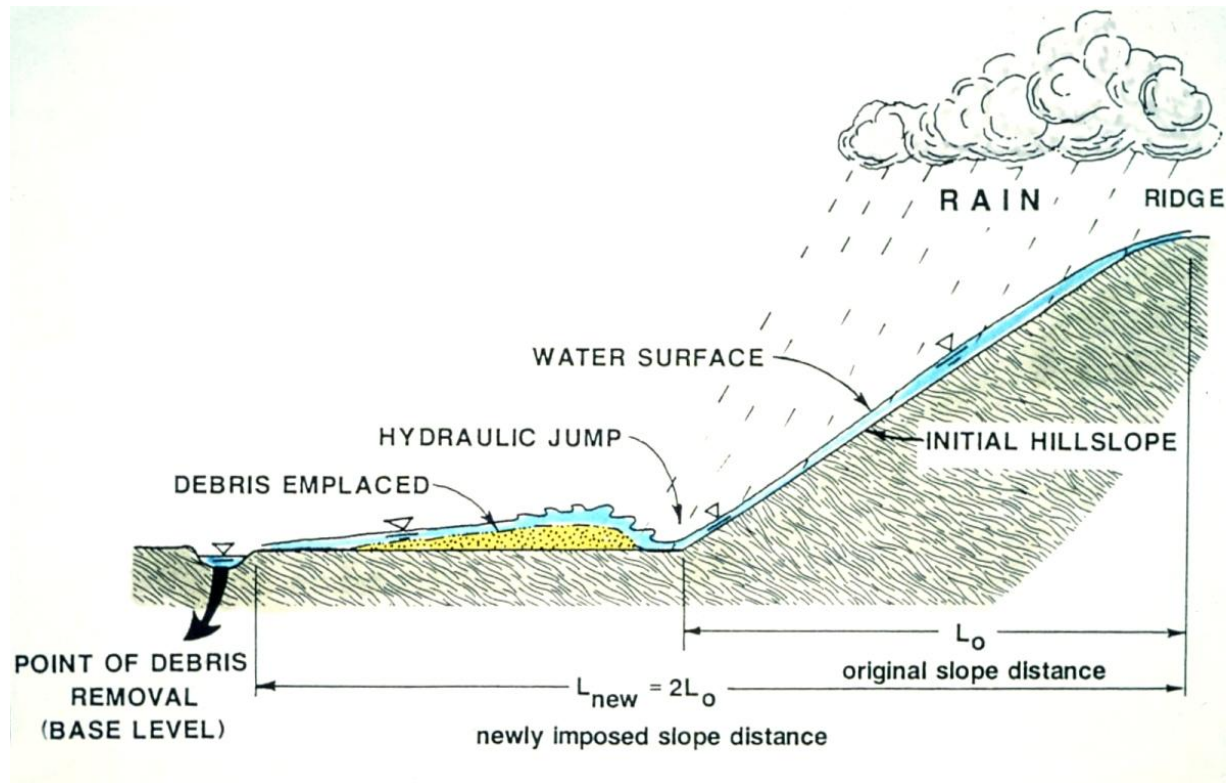

- **When an embankment is constructed with an abrupt change in slope at its toe, eroded material will tend to infill the transition area during low flow, depositing material to create a more gradual transition**

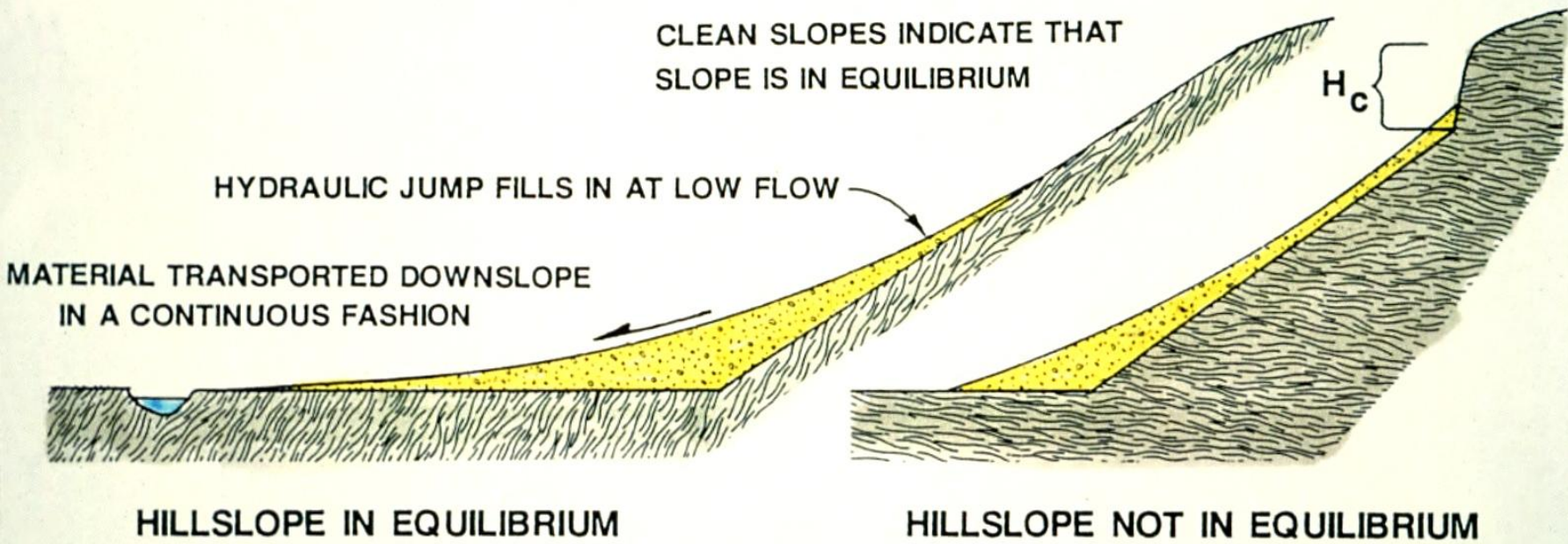

- Physical factors controlling erosion include:
- Slope height and inclination, material type (cohesion and friction), distance to controlling base level (nearest drainage course)

Rounding Slopes

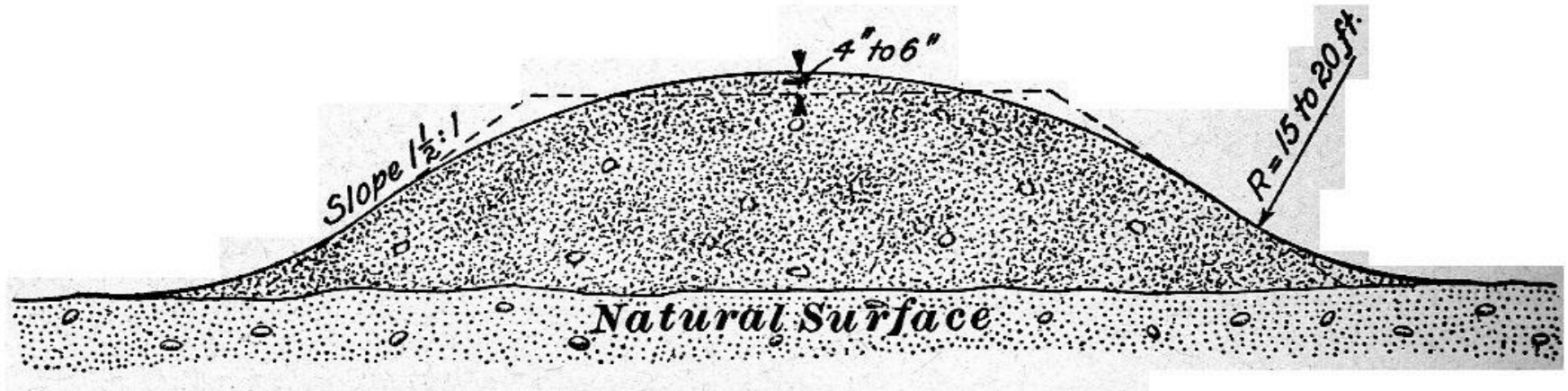

- Suggested standards taken from a general civil engineering text for highway engineering in 1900.
- Note 4 to 6 inch crowning of embankment to promote good drainage; and
- Suggested transition at base of embankment with the native ground surface; with a radius of 15 to 20 ft.
- This transition is important for reducing unnecessary erosion at the base of the fill slope.



- **Hillsides that are out-of-equilibrium will generally experience sporadic erosion problems, generally during periods of sustained intense precipitation, when more water infiltrates the slope than is able to percolate through the weathered regolith**

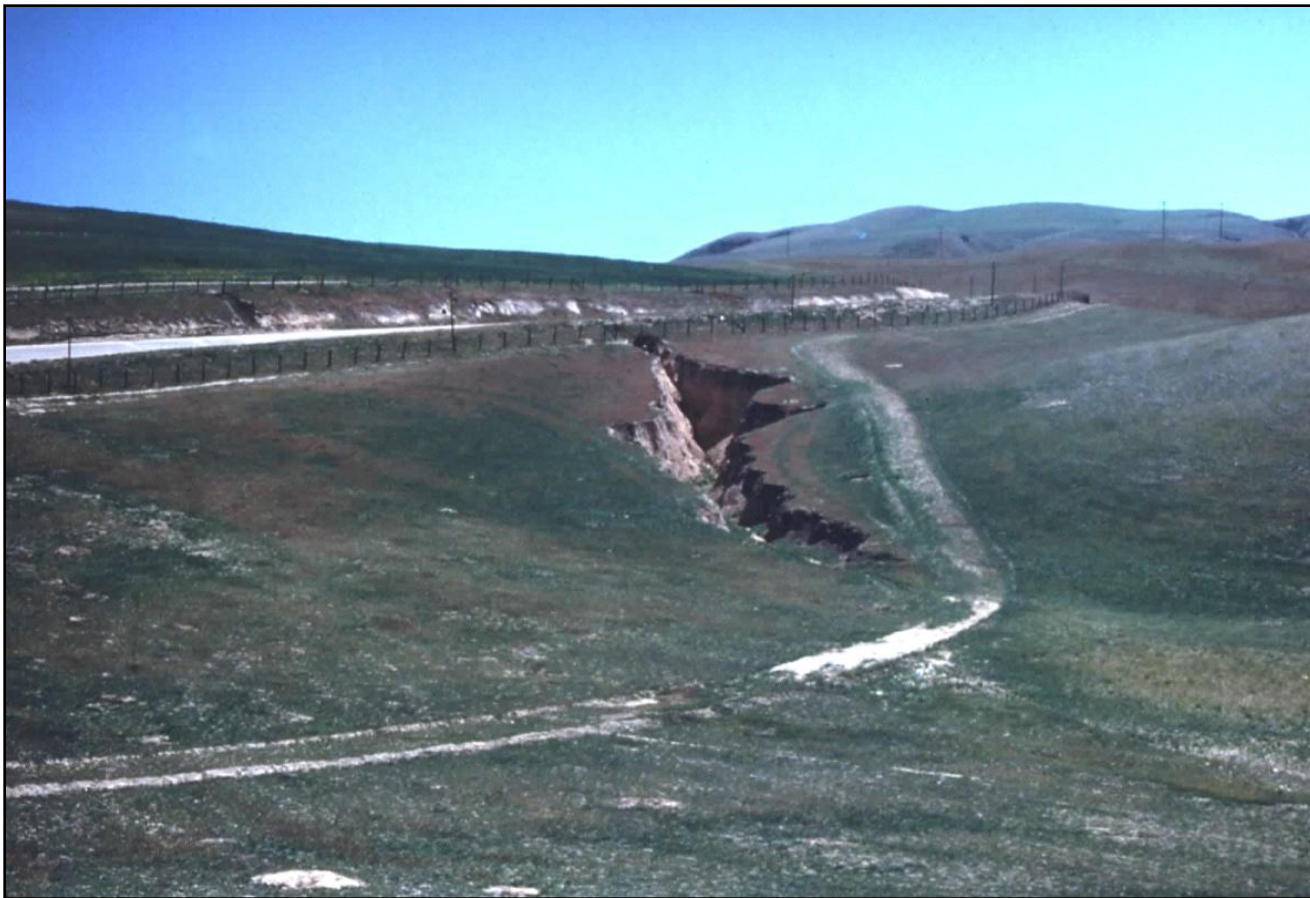

- **Unnatural concentration of surface runoff often causes severe erosion, usually emanating from hardened surfaces, such as streets, parking lots, roofs and paved drainage ditches.**



- **This erosion gully was created from concentrated runoff spilling off the upper parking lot. Simple grass cover cannot always prevent erosion.**

1. Set posts and excavate a 4"x4" trench upslope along the line of posts.

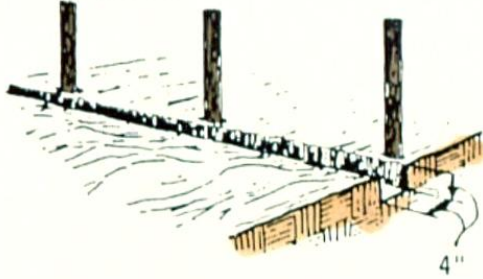

2. Staple wire fencing to the posts.

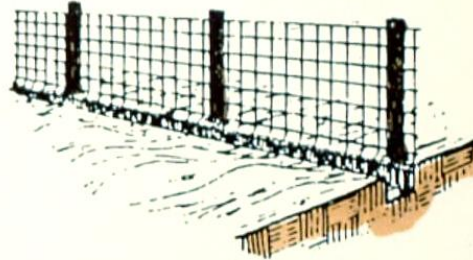

3. Attach the filter fabric to the wire fence and extend it into the trench.

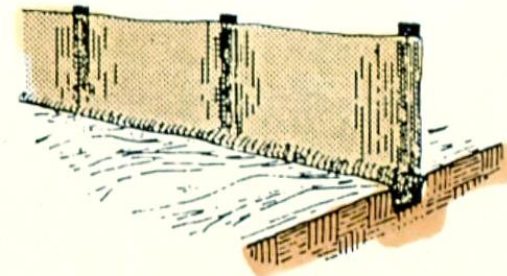

4. Backfill and compact the excavated soil.

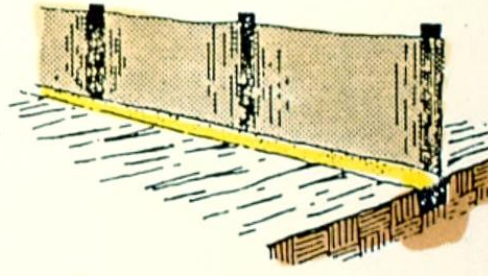

Extension of fabric and wire into the trench.

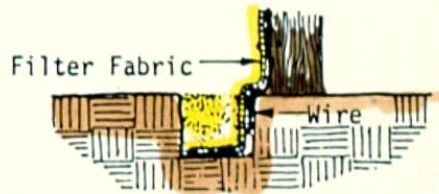

CONSTRUCTION OF A SILT FENCE

- **Silt fences are used as temporary catchment devices, usually during construction and months thereafter, until a healthy cover of vegetation can take root.**
- **Silt fences are now made of geotextiles, but can be reinforced with welded wire mesh**



- **This view shows a typical application of a silt fence below a construction site. The fence is intended to restrict migration of eroded sediment into drainage improvements of natural watercourses**

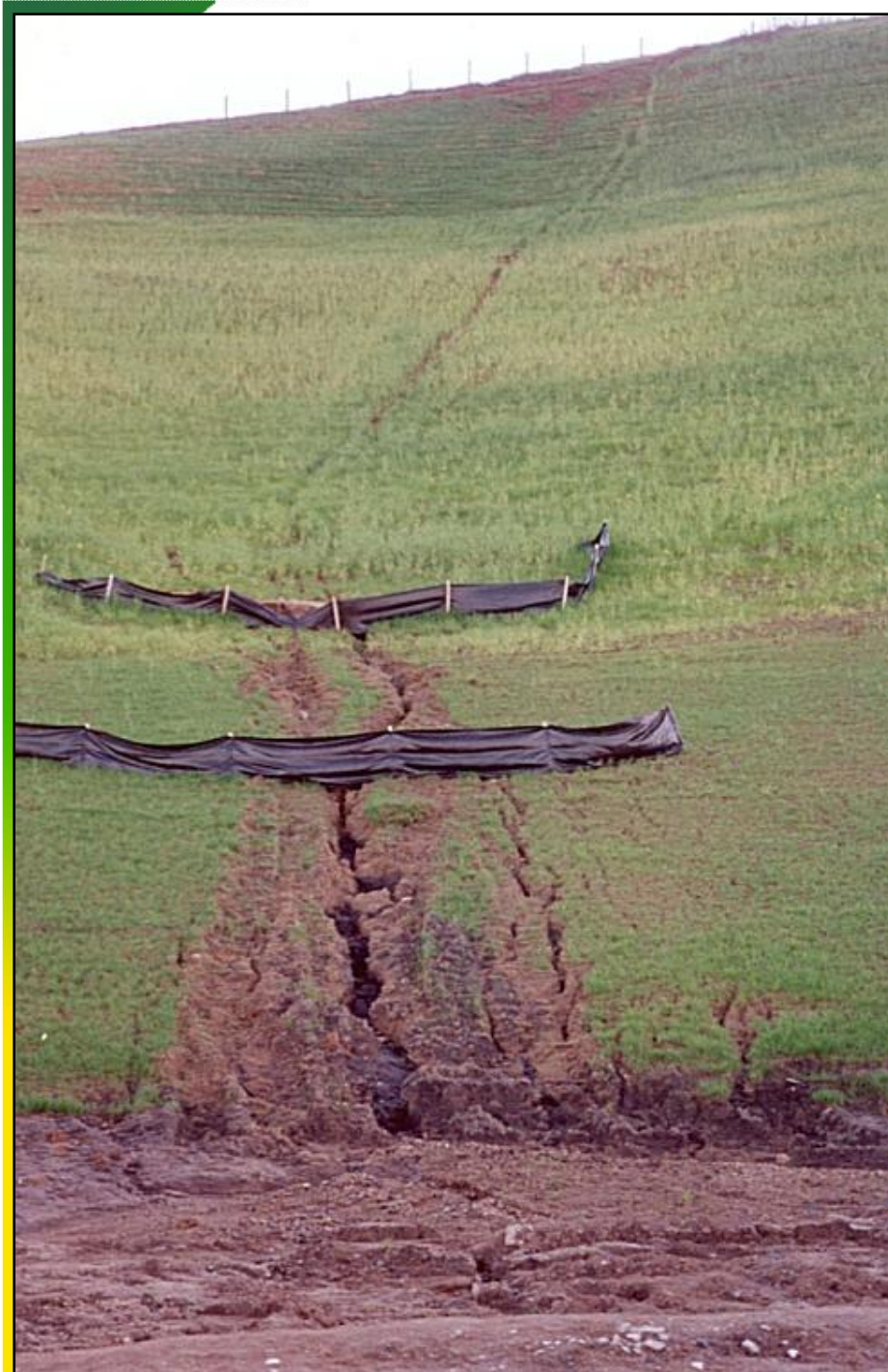

- **Silt fences cannot prevent rill erosion**
- **Long slopes allow concentration of runoff, even on gradual inclinations (e.g. 3:1)**
- **Concave shaped slopes, like that shown here, tend to concentrate runoff by areal accretion**

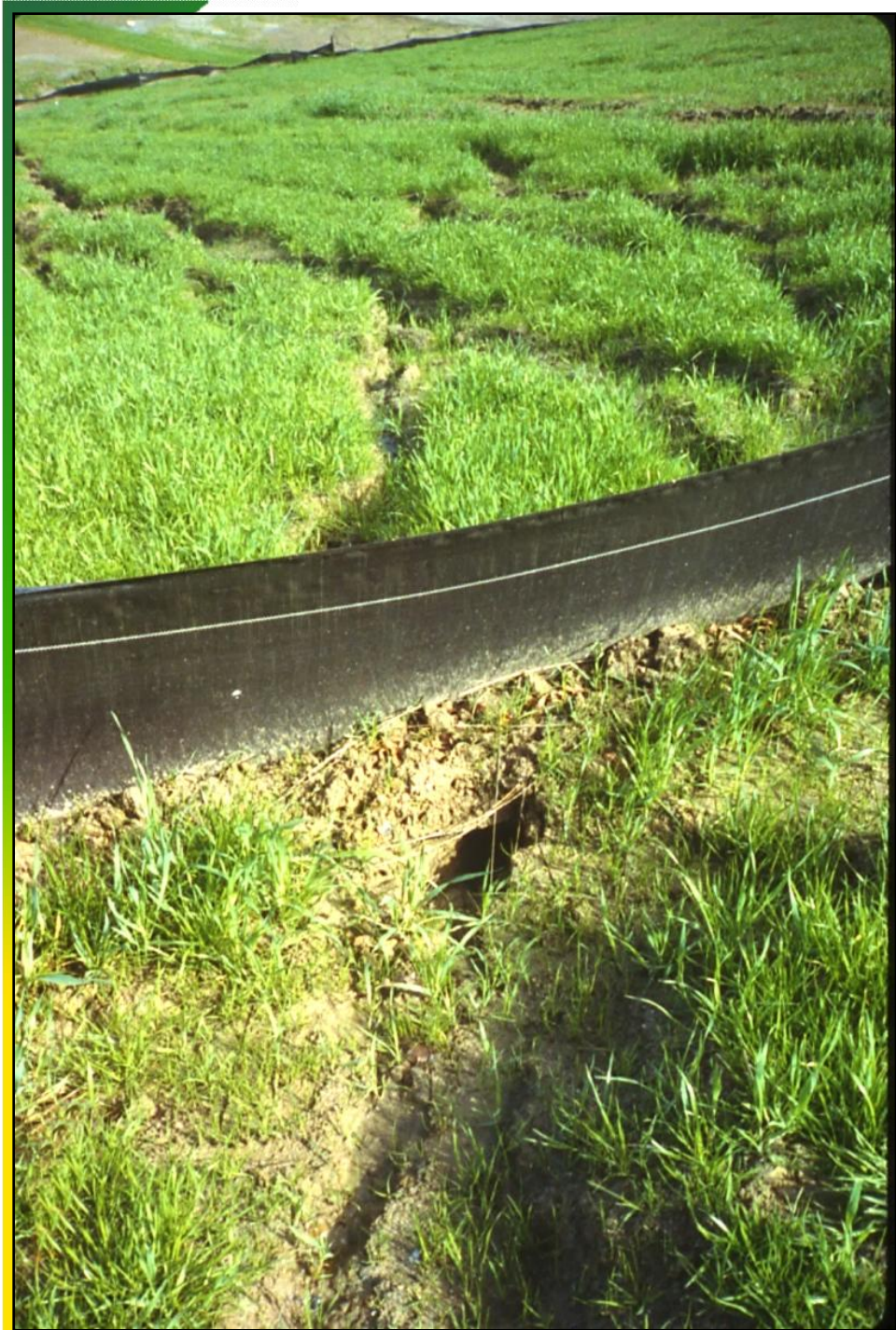

- **The effectiveness of a silt fence is tied to how well it is anchored to the slope.**
- **This slope was hydroseeded and supported a lush growth of fescue grass; and the silt fence was embedded into the slope**
- **Despite these precautions, rill erosion occurred**



- **Silt fences that are placed on slopes or intended to be placed in use for more than a month should be reinforced with welded wire mesh and either steel fence posts or steel pipe posts**



- **Temporary siltation ponds provide a mechanism for catching and holding eroded sediment. The pond should be equipped with a perforated riser and armored spillway**



- **Left unchecked, erosion of the weathered slope mantle may continue until such a time that mass movements initiate, as shown here**

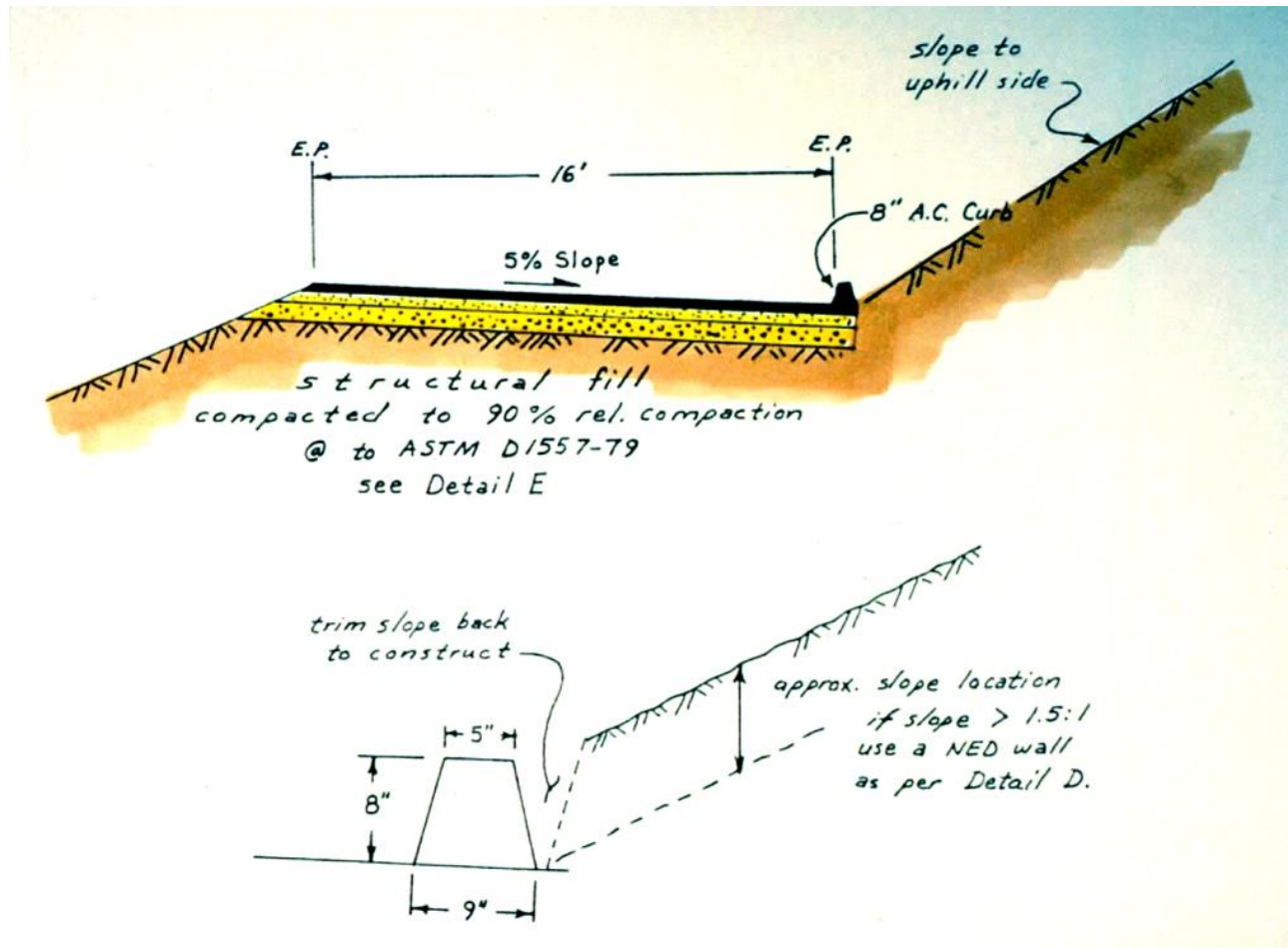

- **A 5% cross slope is a wise precaution on hillside roads, especially when constructed on cut-fill prisms, which are subject to long-term settlement.**



A strong cross slope trains runoff to the inboard side of the road and promotes self-cleaning through supercritical flow along the gutter line, as shown here. The drop inlet needs to be provided with debris catchment so it won't easily clog.

Part 2

DRAINAGE INTERCEPTOR DITCHES

Interceptor Ditches

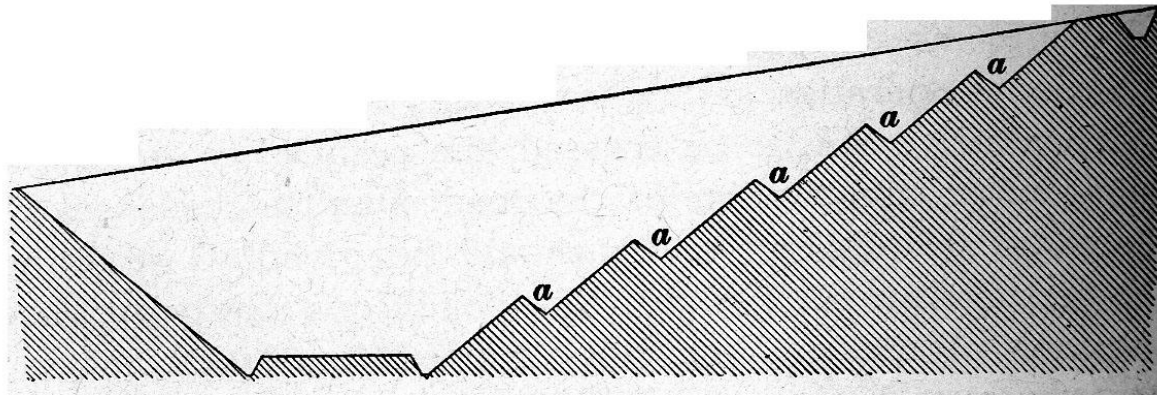

- **Drainage interceptor ditches have been used for over 100 years to mitigate development of erosion rills and gullies on cut or fill slopes. This example is taken from a civil engineering reference book published in 1902.**



- **The intended purpose of paved drainage interceptor ditches is to prevent rill erosion and surficial failures of graded slopes**



- **Terraced slopes should be vegetated to reduce surface erosion, increase unit shear strength through root development, and retard desiccation of cohesive soils**



- **Concrete-lined drainage interceptor ditches should be designed with adequate freeboard and backslope to accommodate modest volumes of spillage off the slopes**

CONTRA COSTA B-58

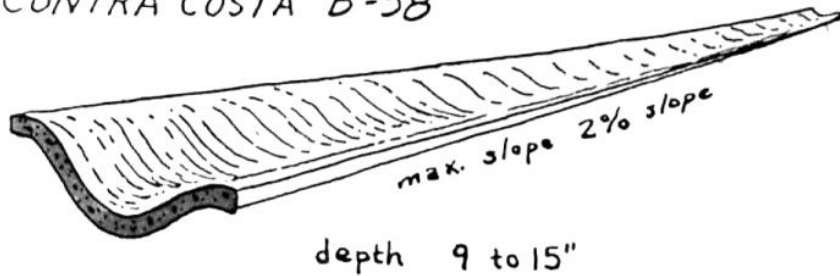

U.B.C. Ch. 70

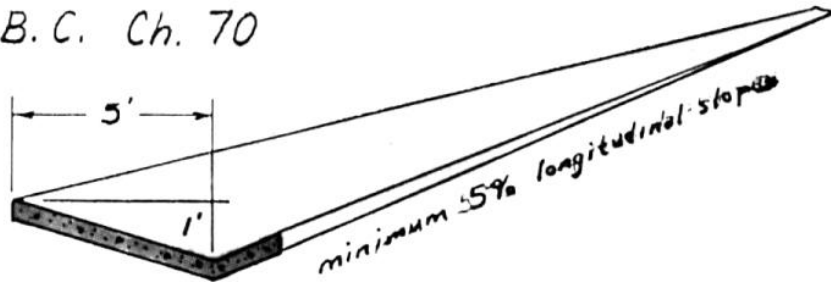

ORANGE COUNTY

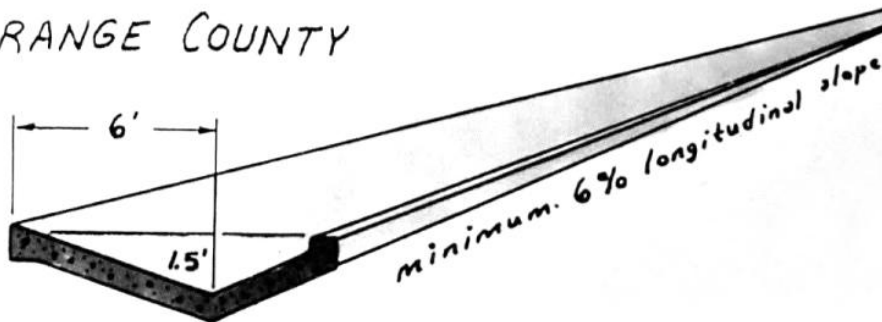

- There are many varieties of paved drainage interceptor ditches
- The most important aspect is watching the longitudinal hydraulic grade
- A grade of 5% to 6% helps ditches to be “self-cleaning” by increasing velocity sufficiently to carry off soil and debris that collects on the ditch

Interceptor Ditches at brow of cut slopes

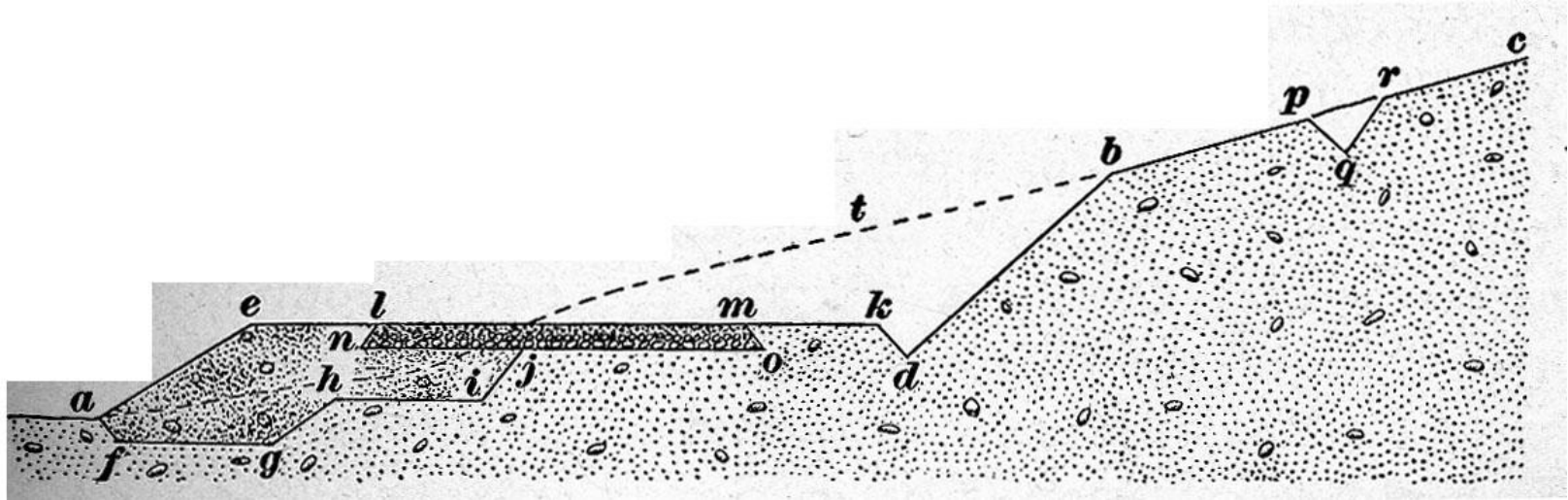

- Here is another “standard grading detail,” taken from a general engineering text around 1900
- It shows a drainage interceptor ditch (p-q-r) above the brow of a cut slope. Note the drainage ditch cut along the upslope heel of the highway, at k-d, and the toe-of-fill keyway at a-f-g-h.

STRUCTURE "A"
INTERCEPTING TERRACE FOR SLOPES

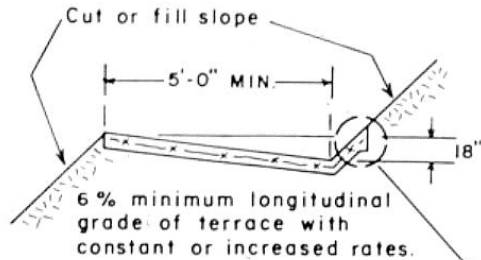

STRUCTURE "B"
DIVERTER TERRACE
TOP OF CUT SLOPES

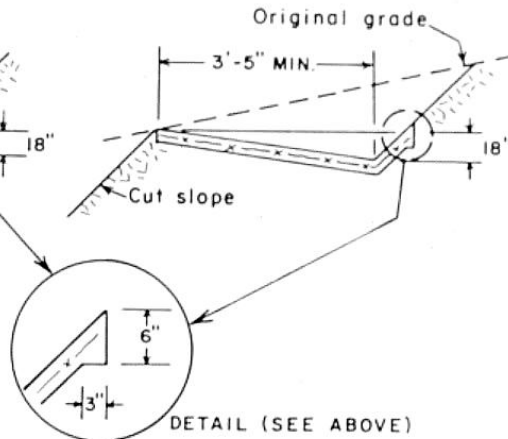

STRUCTURE "C"

TO CONDUCT TERRACE DRAINAGE TO THE STREET OR IMPROVED DRAINAGE DEVICE

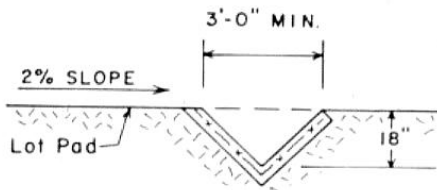

Capacity should be adequate to handle anticipated flow and must be checked by the designing Civil Engineer.

STRUCTURE "D"
DOWN DRAIN AND ANCHOR

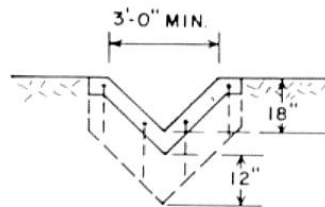

Down drain anchors to be constructed every 10' of vertical height.

Suggested minimum reinforcement, Structure "D"
#3 bars as shown with
#3 tie bars 4' O.C. anchor
dowel to be tied to longitudinal bars
or 6" X 6" #10 #10 W.W.M.

NOTE: Grading inspection during installation is required for all devices. Must pre-wet graded swale prior to paving. Paved drains must be cured with a moisture loss retarder.

Suggested minimum reinforcement for Structures "A", "B", & "C"
3" concrete with #3 bars longitudinal 24" O.C. with #3 tie bars 4' O.C.
3" gunite with 2" X 2" #14 #14 W.W.M.

Redrawn from County of Orange, CA.; Minimum design recommended by Michael Scullin.

- Typical paved drainage interceptor ditch details
- Brow ditches are placed above cut slopes
- The UBC mandates downdrains for every 13,500 sq ft of tributary slope area
- Downdrains need 12 in deep shear keys
- Concrete ditches should be reinforced



- **This failure occurred because the interceptor ditches were not paved, although the downdrain was. The colluvium shown here was very susceptible to erosion because of low cohesion**

Material	Mean Velocity	
	Clear water, ft/sec (m/sec)	Silty water, ft/sec (m/sec)
Fine sand, colloidal	1.50 (0.457)	2.50 (0.762)
Sandy loam, noncolloidal	1.75 (0.533)	2.50 (0.762)
Silt loam, noncolloidal	2.00 (0.610)	3.00 (0.914)
Alluvial silts, noncolloidal	2.00 (0.610)	3.50 (1.067)
Ordinary firm loam	2.50 (0.762)	3.50 (1.067)
Volcanic ash	2.50 (0.762)	3.50 (1.067)
Stiff clay, very colloidal	3.75 (1.143)	5.00 (1.524)
Alluvial silts, colloidal	3.75 (1.143)	5.00 (1.524)
Shales and hardpans	6.00 (1.829)	6.00 (1.829)
Fine gravel	2.50 (0.762)	5.00 (1.524)
Grade loam to cobbles, noncolloidal	3.75 (1.143)	5.00 (1.524)
Graded silts to cobbles, noncolloidal	4.00 (1.220)	5.50 (1.676)
Coarse gravel, noncolloidal	4.00 (1.220)	6.00 (1.829)
Cobbles and shingles	5.00 (1.524)	5.50 (1.676)

- **Unlined channels are capable of conveying runoff with modest velocities, as suggested in this table of limiting values**



- **Fiberglass threads, termed “roving”, can be used to reinforce cohesionless soils, like this cylinder of sand**
- **The fiberglass threads engender considerable shear strength to the soil mass, increasing it’s strength and resistance to erosion**

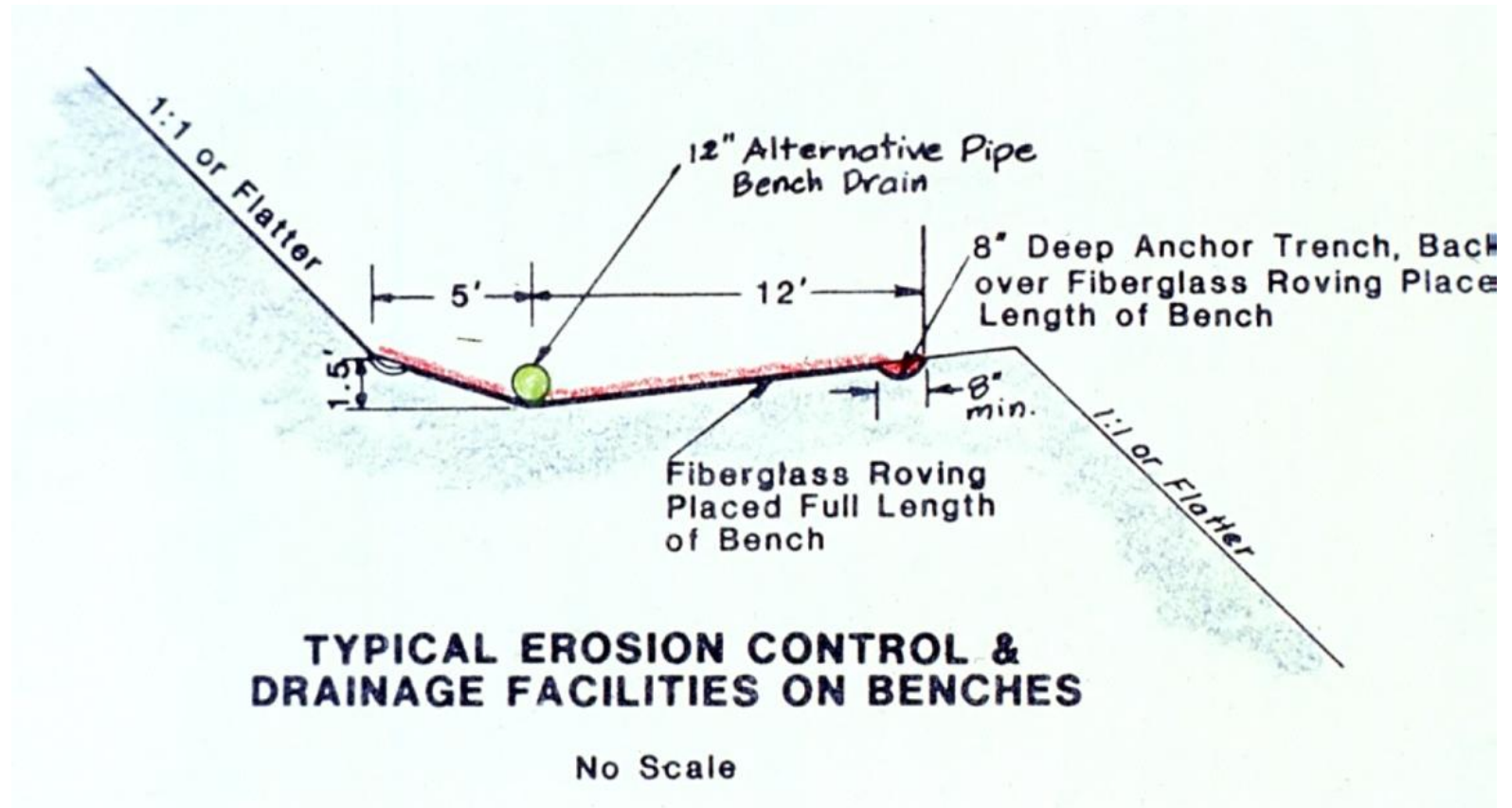

- Section through drainage interceptor ditch lined with fiberglass roving soil reinforcement



- **Fiberglass roving was used to reinforce this drainage interceptor ditch in lieu of paving at Redwood National Park in northern California**



- **Some equipment manufacturers produce special V-shaped buckets for excavation of drainage interceptor ditches, as shown here**

“J” DITCHES

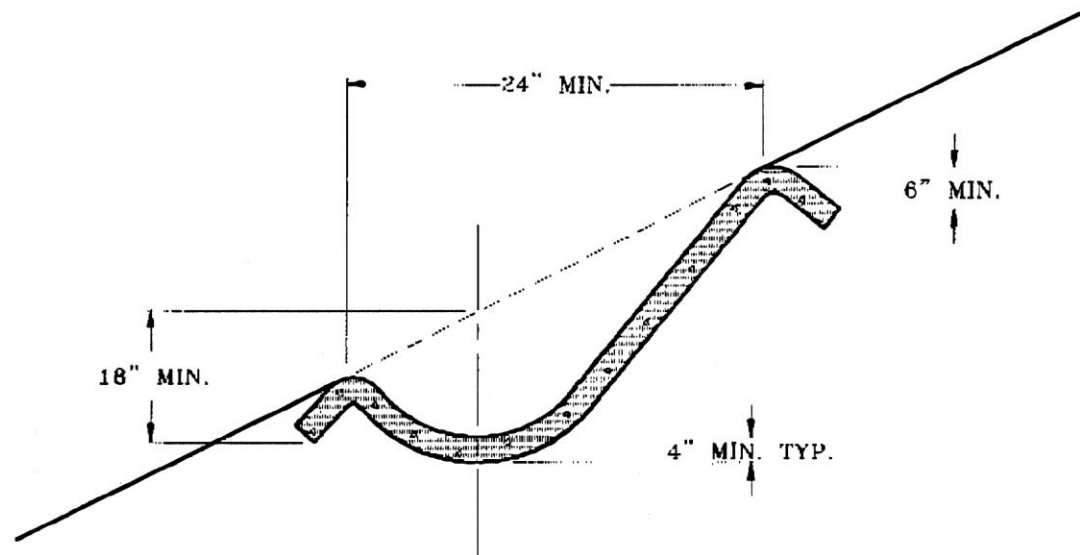

- J ditches are useful because they can be built into existing cut or fill slopes, as shown. They require neat excavation and are typically placed using shotcrete



- **This shows a ditch that was built by excavating an over-steepened cut into a recently graded fill slope, to create a terrace for the drainage ditch. Note surficial failures soon after placement**



- **Another view of a interceptor ditch constructed on an over-steepened cut terrace. Raveling debris from the cut clogged the drop inlet and forced the water onto the slope, causing considerable erosion**



- **Like most manufactured products, drainage ditches require consistent maintenance and upkeep if they are to perform as intended**



- **When hardened drainage improvements fail, the results can be significant. In this case, there was a cold pour gap in the drainage ditch which allowed runoff to infiltrate the fill slope below it, fostering its eventual failure**



- **Downdrains are placed at selected intervals to convey collected runoff down the slope to a suitable point of discharge**



- **This shows a series of concrete-lined downdrains placed on an engineered fill slope**
- **Note the splash walls, which are intended to train debris-laden flows and keep them within the intended flow path**
- **Energy dissipation is required at the foot of such a system, or serious erosion will result**



- This view shows a failed downdrain on a fill embankment
- The failure was precipitated by seepage through a cold pour, or construction joint, which opened up after the toe of the slope was being excavated for a retaining wall



- **Downdrains along the daylight lines of canyon fills require special attention**

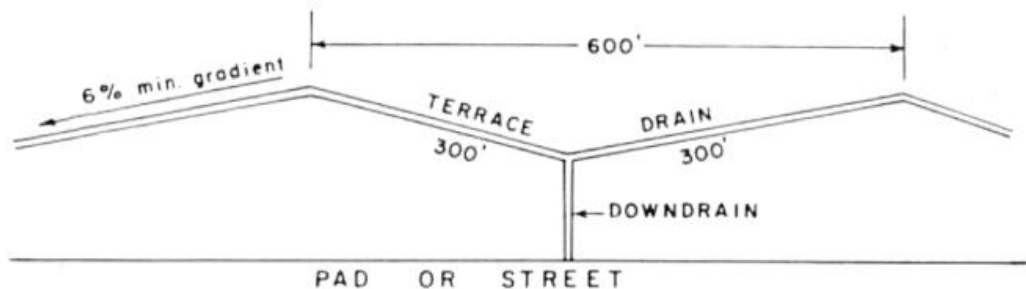

TERRACE DRAINS AND DOWNDRAINS FOR LONG CUT AND FILL SLOPES

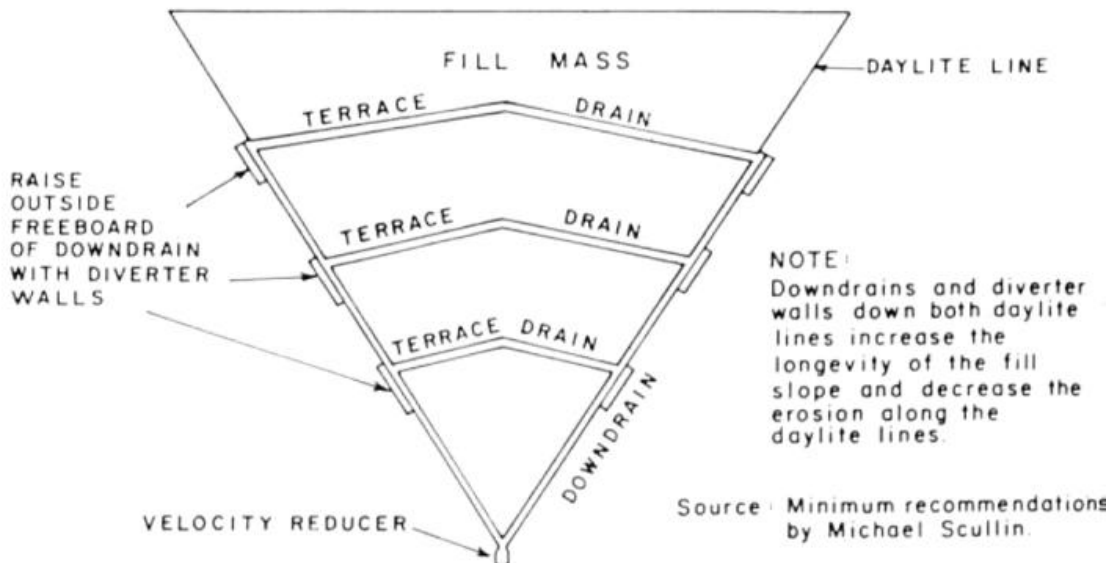
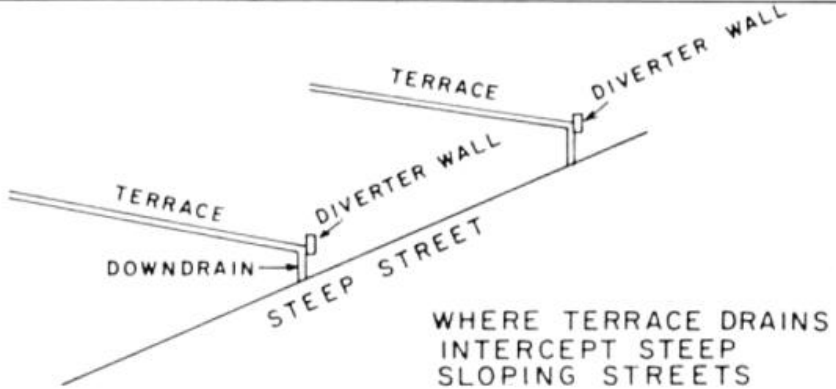

DEEP "V" SHAPED CANYON FILL SLOPE PROTECTION

- Typical details for terrace drains and downdrains on a canyon fill
- Downdrains along the daylight line of the canyon fill are less susceptible to long-term movements caused by settlement of the fill.
- Note diverter walls for training flows

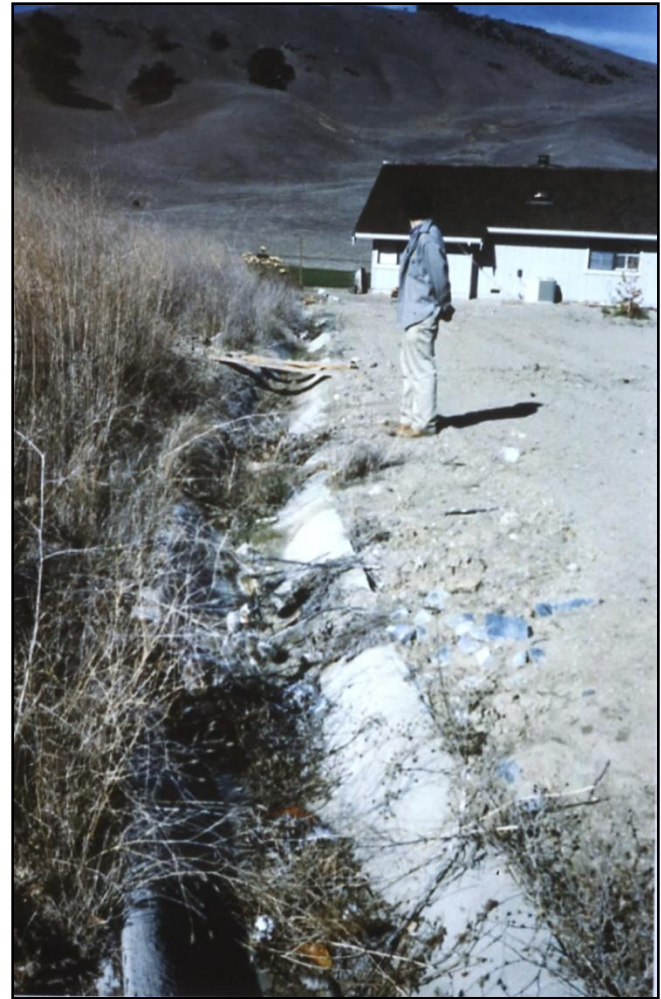

- **Drainage interceptor ditches require ongoing maintenance and periodic selective replacement. Hillside ditches have a design life of between 25 and 50 years**

KEYED & BUTTRESSED 20' WIDE DEBRIS
CATCHMENT/SLOPE MAINTAINENCE BENCH
AT BASE OF SLOPES.

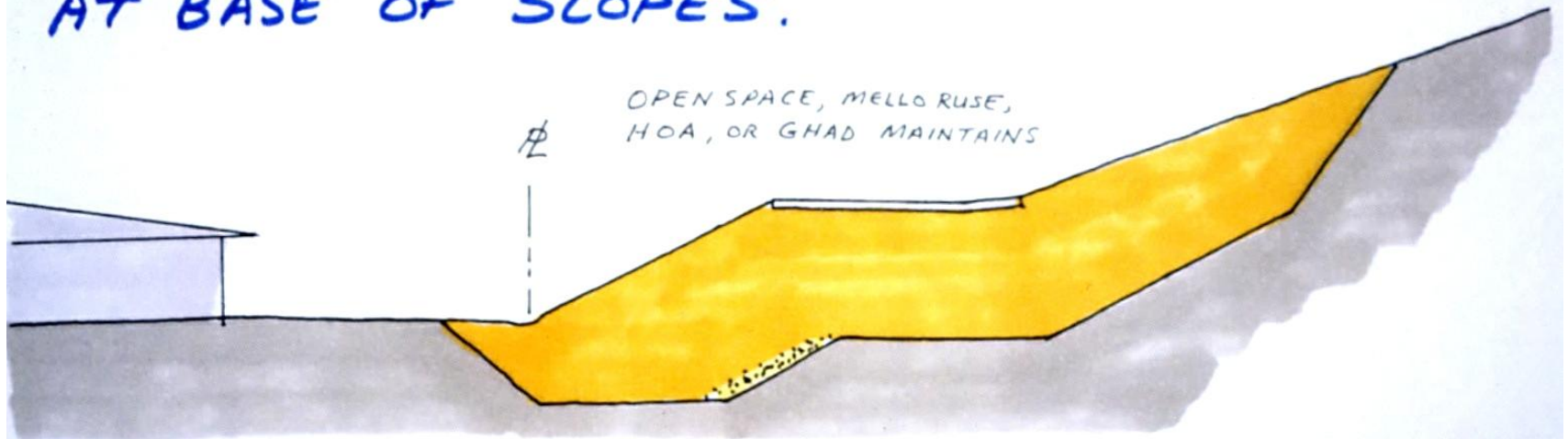

- Debris benches can be used as a buffer between planned unit developments and landslide-prone open space uplands. Wide benches provide storage for fluidized debris and prevent it from impacting structures